



MAIL TO: P.O. BOX 16347 • Louisville, KY 40256-0347
SHIP TO: 3649 Cane Run Road • Louisville, KY 40211-1961
Tel: (502) 778-2731 • 1 (800) 928-PUMP

Visit our website:
zoellerpumps.com

Product information presented here reflects conditions at time of publication. Consult factory regarding discrepancies or inconsistencies.

PIVOT SERIES PUMP CONTROL PANELS

INSTALLATION, OPERATION, AND TROUBLESHOOTING MANUAL

PREINSTALLATION CHECKLIST

1. Inspect your panel. Occasionally, products are damaged during shipment. If the unit or any of the parts are damaged, contact your dealer before using.
2. Carefully read the literature provided to familiarize yourself with specific details regarding installation and use. These materials should be retained for future reference.

INTRODUCTION AND GENERAL INFORMATION

Thank you for your purchase of this Pivot Series control panel from Zoeller Company. The design and function of this product represents the culmination of decades of experience in the water and wastewater pumping industries. This panel has integrated logic designed to protect operators, equipment, and the environment from common mistakes and failures. As one example, this panel is programmed to recognize if float switches malfunction or are installed out-of-order. If an issue is detected, the panel will make adjustments to keep the pump system operational, while also alerting the user to an issue that needs attention. These features add tremendous value for the system owner and service providers. However, some users most familiar with basic electro-mechanical panels may initially find certain behaviors of the Pivot to be unexpected. It is essential that installers and operators understand the operational characteristics of the Pivot as presented in this manual. We are confident that you will also find these features to be logical, useful, and valuable.

The Pivot Series makes use of certain programmed values to guide its behavior when problems are detected in the field. Zoeller has selected default settings for these values that are appropriate for most applications and should not require modification. However, should adjustments be necessary, please refer to the section entitled 'Adjusting Defaults' for instructions on how to customize these settings. Throughout this manual, adjustable default settings are indicated in this manner: (default).

Caution: Please read the following manual carefully before installing or operating the panel.

This panel must be installed and serviced by a licensed electrician in accordance with the National Electric Code NFPA-70, state, and local requirements/codes.

This panel is housed in a NEMA 4X sealed enclosure for indoor and outdoor use. All conduits and cables connected to the panel must be sealed to protect the panel from moisture and gases.

DO NOT DISCARD THIS MANUAL. It contains important information regarding safe use of this product. This manual should always be referenced during installation and operation. Please store this manual in a safe location.

After removing the panel from its package, inspect for any missing components or damage (cracks, dents, scratches, etc.). Damage claims must be submitted to the panel's sales location or distributor.

"This Technical Guide is aimed at professional users and is only intended to provide them guidelines for the definition of an industrial, tertiary or domestic electrical installation. Information and guidelines contained in this Guide are provided AS IS. Zoeller Pump Company and its parent company Zoeller Company makes no warranty of any kind, whether express or implied, such as but not limited to the warranties of merchantability and fitness for a particular purpose, nor assumes any legal liability or responsibility for the accuracy, completeness, or usefulness of any information, apparatus, product, or process disclosed in this Guide, nor represents that its use would not infringe privately owned rights. The purpose of this guide is to facilitate the implementation of International installation standards for designers & contractors, but in all cases the original text of International or local standards in force shall prevail. Professional installers should adapt these guidelines as required for their specific circumstances as required for each application and their specific jurisdiction."

LIMITED WARRANTY

Manufacturer warrants, to the purchaser and subsequent owner during the warranty period, every new product to be free from defects in material and workmanship under normal use and service, when properly used and maintained, for a period of 5 years from date of purchase by the end user. Proof of purchase is required. Parts that fail within the warranty period, that inspections determine to be defective in material or workmanship, will be repaired, replaced or remanufactured at Manufacturer's option, provided however, that by so doing we will not be obligated to replace an entire assembly, the entire mechanism or the complete unit. No allowance will be made for shipping charges, damages, labor or other charges that may occur due to product failure, repair or replacement.

This warranty does not apply to and there shall be no warranty for any material or product that has been disassembled without prior approval of Manufacturer, subjected to misuse, misapplication, neglect, alteration, accident or uncontrollable act of nature; that has not been installed, operated or maintained in accordance with Manufacturer's installation instructions; that the interior components of which have been subjected to outside substances including but not limited to the following: moisture, gases, dust, insects or other pests, or corrosive substances in all applications. The warranty set out in the paragraph above is

in lieu of all other warranties expressed or implied; and we do not authorize any representative or other person to assume for us any other liability in connection with our products. Contact Manufacturer at, 3649 Cane Run Road, Louisville, Kentucky 40211, Attention: Customer Support Department to obtain any needed repair or replacement of part(s) or additional information pertaining to our warranty.

MANUFACTURER EXPRESSLY DISCLAIMS LIABILITY FOR SPECIAL, CONSEQUENTIAL OR INCIDENTAL DAMAGES OR BREACH OF EXPRESSED OR IMPLIED WARRANTY; AND ANY IMPLIED WARRANTY OF FITNESS FOR A PARTICULAR PURPOSE AND OF MERCHANTABILITY SHALL BE LIMITED TO THE DURATION OF THE EXPRESSED WARRANTY. IN NO CASE, SHALL THE AMOUNT COVERED BY THE WARRANTY EXCEED THE PURCHASE PRICE.

Some states do not allow limitations on the duration of an implied warranty, so the above limitation may not apply to you. Some states do not allow the exclusion or limitation of incidental or consequential damages, so the above limitation or exclusion may not apply to you. This warranty gives you specific legal rights and you may also have other rights which vary from state to state.

In instances where property damages are incurred as a result of an alleged product failure, the property owner must retain possession of the product for investigative purpose.

SPECIFICATIONS

This product monitors and controls liquid levels in pump stations, sump pump basins, and other non-potable water applications. The Pivot control panel must be hardwired to a 120V, single phase, 60Hz AC power source. Additionally, the Pivot must be supplied with the appropriate single phase voltage as required by the pump(s).

⚠ CAUTION
RISK OF ELECTRIC SHOCK - More than one disconnect switch may be required to de-energize equipment before servicing.

⚠ ATTENTION
RISQUE DE CHOC ÉLECTRIQUE - Plus d'un interrupteur de déconnexion peut être nécessaire pour mettre hors tension avant de procéder à l'entretien de l'équipement.

⚠ PRECAUCIÓN
RIESGO DE DESCARGA ELÉCTRICA - Puede ser necesario desconectar más de un interruptor para desenergizar el equipo antes del mantenimiento.

FM3193

Warranty void if panel is modified in ways not described in this manual.

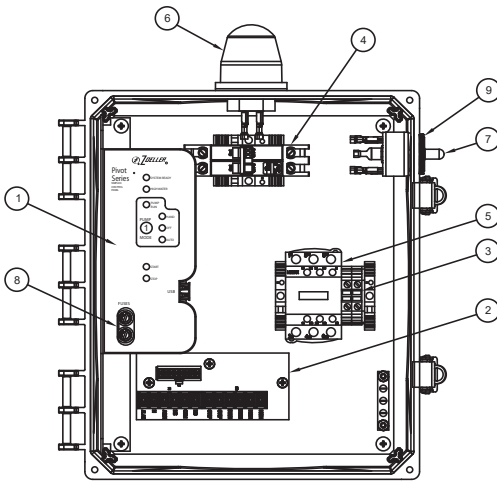

Simplex Pivot

- 1) User Interface
- 2) Terminal Board
- 3) Pump Power Terminals (TB1)
- 4) Pump Circuit Breaker(s)
- 5) Motor Contactor(s)
- 6) Globe
- 7) Test/Silence/Reset Switch
- 8) Fuses & Fuse Holders
- 9) Alarm Buzzer

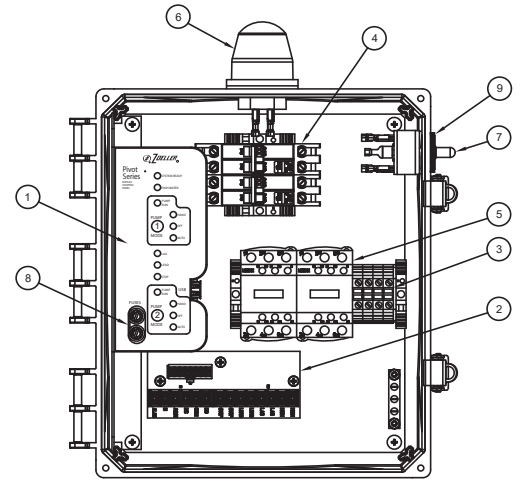

Duplex Pivot

INSTALLATION

The Pivot panel is designed to control submersible pumps in demand-dosing applications. The controller uses float switches to monitor the liquid levels in a wet-well, and it will show and sound alarms in response to high-water and other fault conditions. It will also record operating statistics including number of pump cycles and pump elapsed-run times.

Float Installation

The Pivot panel is designed to operate in most applications (simplex or duplex) with 3 normally-open float switches. See warning below before installing 4 floats into a duplex application. Pro Tip: Mark float switches with unique identifiers on both ends of the cable to assist in proper installation and wiring.

WARNING: Most applications for this control panel should only utilize 3 float switches. Installing 4 floats may lead to unintended consequences including property damage. Do not install 4 floats into this application unless you read and understand the panel operations described in the notes below.

NOTE: Most duplex Pivot panels will be installed into residential or small commercial systems where the second pump exists purely for redundancy rather than from a need to run pumps simultaneously during high flow events. In most residential or small commercial applications, one pump will be sufficient to handle the incoming flow. Should the water level in the wet well rise enough to engage the second pump, it is indicative of a problem (i.e. pump failure, stuck float, etc.) and an alarm should sound. The addition of a 4th float into this type of system will mask pump failures, stuck floats, etc. unless changes are made to the default settings. To avoid issues, Zoeller recommends the use of only 3 floats.

NOTE: Municipal applications may require more flexibility than residential or small commercial systems. Applications like storm water lift stations can, at times, receive incoming flow that surpasses what one pump can manage. In these situations, a second pump may need to run simultaneously in order to keep up with the incoming water. Such a condition may not warrant an alarm. For this reason, municipal lift stations sometimes use 4 floats in a Stop, Lead, Lag, High Alarm (SLLH) configuration to provide the lag pump with time to function before an alarm occurs. If 4 floats are used, the Pivot panel expects the float order to be SLLH (default). However, the same 4 float configuration in a residential or small commercial application will simply mask problems until additional critical failures occur.

Caution: Turn off all power sources before performing any work inside the pump chamber. Failure to do so could result in potentially fatal electrical shock hazards.

- 1) Prepare the required number of float switches (3 for most applications) and choose suitable location levels in the wet well for their operation. Refer to the system design (provided by others) for the correct float locations to ensure the system will function properly.

NOTE: Optimal float positions depend on the application system design (provided by others).

- 2) Secure the float switches in the appropriate positions in the wet well and verify that they have free range of motion and do not interfere with any other equipment. Verify that the cables cannot be cut, pinched, or otherwise damaged throughout each float's range of motion.

Simplex Pivot panels operate using three floats. These floats should be installed in the following order from highest to lowest:

- High Water Alarm
- Start
- Stop

Alternating duplex Pivot panels are designed to utilize just three floats for the majority of applications. These floats should be installed in the following order from highest to lowest:

- Lag / High Water Alarm
- Lead
- Stop

NOTE: Duplex Pivot panels ship from the factory with a preinstalled jumper wire linking the Lag and High Water Alarm float terminals. In the majority of applications there is no reason to separate the functions of the Lag and High Water Alarm. For this reason, it is recommended that for standard installations, the jumper remain in place and only 3 floats be used. The top float should be connected to the High Water Alarm terminals.

In rare cases (mostly municipal), a duplex application may require 4 floats. See warning above. When in doubt about the required number of floats, the conservative (and recommended) approach is to utilize the 3 float installation as indicated above. If 4 floats are necessary, the Pivot panel's default settings require that they be installed in the following order from highest to lowest:

- High Water Alarm
- Lag
- Lead
- Stop

NOTE: The preinstalled jumper wire must be removed from terminal board if 4 floats are used.

NOTE: If local codes require the use of 4 floats in a residential or small commercial duplex application, it will be necessary to modify the Pivot panel's default settings regarding float order. Residential or small commercial duplex applications should utilize a Stop, Lead, High Alarm, Lag (SLHL) float order rather than the default Stop, Lead, Lag, High Alarm (SLLH) configuration. Refer to the section entitled 'Adjusting Defaults' for instructions on how to customize these settings.

Mounting the Control Panel

Caution: Do not mount the panel in an area that could become submerged in water or other liquids.

- 1) Determine where the panel should be placed. If the distance from the panel to the pump chamber exceeds the length of either the float cables or the pump power cables, ensure that only appropriate conductors and methods are used to extend the leads.

NOTE: Never use extension cords to extend electrical service to pump motors.

- 2) Fasten the mounting feet to the panel enclosure.
- 3) Mount the control panel in the desired location.
- 4) Locate the most appropriate positions for the wiring conduits or connectors in the bottom of the panel enclosure. For the required number of power circuits, reference the local electrical codes and schematics. Separate conduits are needed to isolate the float cables from power and pump cables.

Caution: Float switch cables must be wired into the panel separately from pump and power cables. Ensure the power supply voltage, amperage, and number of phases meet the requirements of the pump motor(s) being installed. If in doubt, see the pump identification plate for voltage/phase requirements.

- 5) Cut the appropriately sized holes for the wiring conduits or cable connectors.

NOTE: Verify that there is enough space in the wiring conduits or connectors for all the power and pump cables.

- 6) Secure the wiring conduits or cable connectors to the control panel.
- 7) Pull the appropriate conductors through the conduits to the panel.

WARNING: Ensure all power sources are off before pulling or connecting any wiring. Failure to do so can result in potentially fatal electric shock hazards.

Caution: To prevent gases or moisture from entering the panel, wiring conduit seals or panel connector seals must be used. Additionally, the application of a duct seal putty is recommended to seal the conduit ends.

Incoming Power Requirements

Each Pivot is designed with isolated electrical circuits which separate the panel's control functions from its alarm functions. This redundancy is beneficial and may be required by code in some jurisdictions. Likewise, separate circuits are provided for each pump in the system. The following tables indicate the electrical drops necessary to power up Pivot panels. In some circumstances it may be possible to use jumper wires to service multiple circuits from a single power supply, though providing separate circuits is recommended. The tables categorize the power supply options from Optimal to Adequate.

NOTE: Best practice is to bring in separate electrical feeds for the control power and for the alarm power. This ensures that the alarm circuit will still be operable should an unexpected surge disable the control circuit. **If separate circuits are not available, it will be necessary to connect a jumper wire from the Alarm A/C (ALAC) terminal to the Control A/C In (AC.IN) terminal.** The jumper wire, if needed, should be sized per local code and constructed of the same conductor material used for the original electrical feed. If neither separate circuits nor a jumper is used, the panel will not operate properly.

Caution. Always ensure that the source wiring and breakers are sized sufficiently to carry the load required of the circuits they service.

Single Phase, Simplex

	Control Power	Alarm Power	Pump Power
Optimal	120V, 1PH	120V, 1PH	120V or 230V*, 1PH
Standard	120V, 1PH	Jumper** from Control	120V or 230V*, 1PH

Single Phase, Duplex

	Control Power	Alarm Power	Pump 1 Power	Pump 2 Power
Optimal	120V, 1PH	120V, 1PH	120V or 230V*, 1PH	120V or 230V*, 1PH
Standard	120V, 1PH	Jumper** from Control	120V or 230V*, 1PH	120V or 230V*, 1PH

*Consult pump literature for power requirements

**Jumper wire not included

Field Wiring to the Control Panel

All field wiring will connect to either the terminal board, terminal strip (TB1), or the motor contactors directly. Refer to your panel's specific wiring diagram schematic before proceeding with field wiring installation.

NOTE: Refer to the wiring diagram for the appropriate torque specifications for each terminal type.

- 1) Connect all ground wiring to the ground bus bar in the panel. Ensure the bus bar is properly grounded per local code.
- 2) Connect the wiring for each float switch to the appropriately labeled lugs on the terminal board.
- 3) Connect the power cord wiring from the pump(s) directly to the motor contactor(s).
- 4) Connect the control power supply wiring to the terminal board lugs labeled "AC.IN" and "N".
- 5) If a dedicated power supply exists for the alarm circuit, connect the alarm power supply wiring to the terminal board lugs labeled "ALAC" and "N". If only one power supply is used for both the control and alarm circuits, connect a jumper wire between the Alarm A/C (ALAC) terminal to the Control A/C In (AC.IN) lugs.
- 6) Connect the appropriate pump supply power wiring to the Pump Power Terminal Strip labeled "TB1".

After the equipment is mounted and wired but before power is applied, double-check all wiring by gently tugging on each wire to ensure a tight connection. Power up the panel and test it to verify that the control panel operates correctly.

USER INTERFACE

This Pivot Series Control Panel features a bracket-mounted user interface inside the enclosure and an alarm Test/Silence/Reset toggle switch outside the enclosure (right side). The layout of the internal interface varies slightly depending on the model. The common user interface features are indicated below.

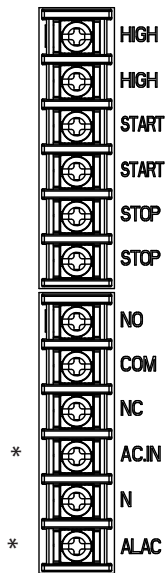

*Both Control and Alarm terminals require power for proper operation.

Terminal Board Connections for Pivot Simplex

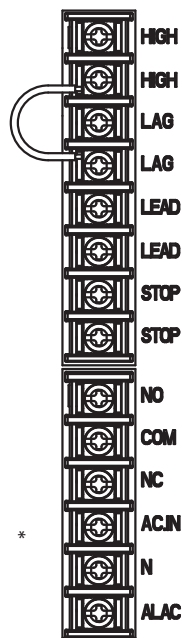

Terminal Board Connections for Pivot Duplex

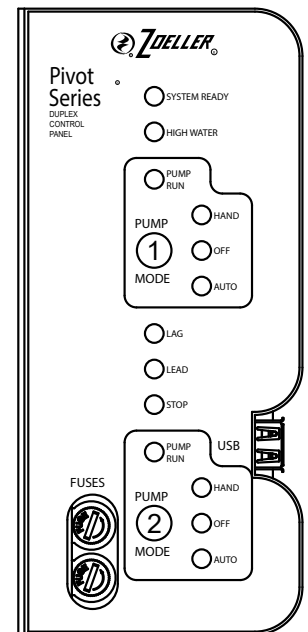
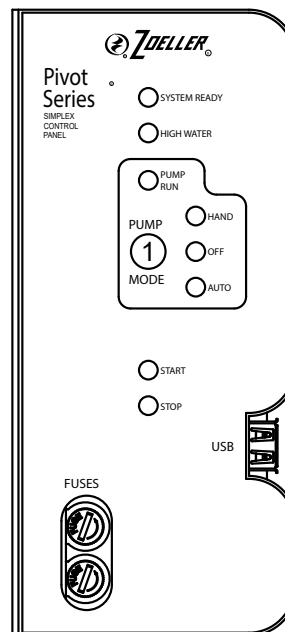

Bracket-Mounted User Interfaces: Simplex and Duplex

System Ready Indicator

This Green LED indicates that power has been successfully applied to both the control and alarm circuits, the pump(s) are placed into Auto Mode, and the panel is ready to function properly without any faults.

High Water Indicator

The Red High Water LED indicates that the high water float is or has been tripped and can mean either A) a high water condition is currently present, or B) a high water condition previously occurred and has been corrected but the alarm has not yet been manually reset. To manually reset the High Water Indicator, hold the Test/Silence switch on the right side of the enclosure in the down (Silence) position for 3 seconds.

Pump Run Indicator

The Pump Run LED may appear Green, Red, or Amber. A Pump Run LED exists for each pump in the system. This indicator illuminates Green whenever the associated pump is being called to operate. An Amber or Red Pump Run LED indicates a less common problem. Refer to the Alarm Condition Faults section for information on deciphering different LED conditions.

Pump Mode Button

The Pump Mode Button toggles between the three possible pump modes: HAND, OFF, and AUTO. A Pump Mode Button exists for each pump in the system.

HAND MODE – Solid Blue LED. Placing a pump into Hand Mode will activate the pump regardless of float status. A pump placed into Hand Mode will run continuously until either the Pump Mode is changed by the user or 5 minutes (default) elapse. If the pump remains in Hand Mode beyond 5 minutes (default), the Pump Mode will automatically revert to Service Off Mode.

Caution: Hand mode is meant as a short-term method to manually run a pump. Always monitor the water level and remember to return the panel to Auto Mode. Pumps operating in Hand Mode ignore floats and are at risk of running dry if the liquid in the wet well is depleted. Such a condition may cause damage and/or failure of the pump.

OFF MODE 1: SERVICE – Solid Red LED. Placing a pump into Service Off Mode will prevent the pump from running regardless of float status. A pump placed into Service Off Mode will remain in that state until either the Pump Mode is changed by the user or 4 hours (default) elapse. If the pump remains in Service Off Mode beyond 4 Hours (default), the audible and visual alarms will activate to remind the user to return the pump to Auto Mode.

OFF MODE 2: PERMANENT – Blinking Red LED. Placing a pump into Permanent Off Mode will prevent the pump from running regardless of float status. To access Permanent Off Mode, press and hold the Pump Mode Button for approximately 5 seconds. A pump placed into Permanent Off Mode will remain in that state until the Pump Mode is changed by the user. To exit Permanent Off Mode, press the Pump Mode Button.

WARNING: Off Mode (Service or Permanent) is NOT an appropriate lockout method when performing pump maintenance. Always remove the system AC power to lockout the pump(s) by means of a proper upstream circuit breaker or switch disconnect.

AUTO MODE – Solid Green LED. Auto is the proper mode for normal operation. A pump placed into Auto Mode will be called by the panel to start and stop automatically based on the detected status of the float switches. In a duplex application, the control panel will alternate the lead pump with each cycle.

Float Status Indicators

The Pivot utilizes a series of LEDs to convey the status of the individual float switches in the wet well. When a normally-open float switch is lifted by the liquid, its corresponding LED will illuminate Green. This feature quickly shows the operator what float switches the panel believes are in the “up”, or “closed”, position and which are not. It also provides a convenient method for verifying proper float installation and operation. If a particular float is physically lifted, but its corresponding LED does not illuminate, then there is some issue with that float’s circuit which must be addressed. Refer to the Alarm Condition Faults section for information on deciphering different LED conditions.

Alarm Test/Silence/Reset Switch (External)

A momentary toggle switch exists on the right-side exterior of the enclosure and can perform the following functions:

Alarm Test – To verify that the LEDs, globe light, and horn function properly, lift and hold the switch to its ‘up’ position. Releasing the switch will end the test.

Alarm Silence – To silence an audible alarm, press the switch to the down position and release. The alarm will remain active and the globe light will continue to illuminate but the horn will stop.

Alarm Reset – Certain alarms will cause the globe light to persist even if the condition causing the alarm has been rectified. In these circumstances, the alarms must be addressed in person and manually reset. Perform a manual reset by pressing the switch into the ‘down’ position and holding it for 3 seconds.

ADDITIONAL FEATURES

Dry Contacts

Pivot control panels are equipped with Form 'C' dry contacts for use with remote monitoring and external alarm accessories. They are located on the terminal board between the incoming power supply terminals and the float connection terminals. The dry contacts consist of a Normally-Open (NO) terminal, a shared Common (COM) terminal, and a Normally-Closed (NC) terminal. The 'normal' state occurs when the panel is powered up and no alarm conditions exist. In the event of any alarm, the contacts will change from their 'normal' state to the alarm state (normally-open to closed, and normally-closed to open). The contacts will also be changed to the alarm state if the panel power is disconnected regardless of system fault conditions.

To use these dry contacts, the installer will need to supply a live conductor to the COM terminal and then connect the external equipment to either the NC terminal or the NO terminal. These Form 'C' dry contacts can carry a maximum of 5 amps and can operate from 120VAC to 240VAC, or from 12VDC to 30VDC.

Fuses

Two fuses are used for circuit protection in this panel and are located in side-by-side black fuse holders on the lower left edge of the user interface bracket. Each fuse is rated as 3A, fast-acting, 120VAC. The upper fuse protects the main circuit board electronics, and the lower fuse protects the globe light, horn, and floats.

To check the continuity of the fuses, first disconnect the panel power. Remove each fuse and measure its resistance using an ohmmeter. A blown fuse will read as an open circuit (infinitely high resistance). If a fuse is blown, replace it with another identical 3A, fast-acting fuse.

WARNING: Disconnect supply power before checking or changing either fuse.

Factory Reset

To perform a factory reset, press and hold the Test/Silence switch in the down position. After 5 seconds, the System Ready LED will begin blinking. Continue to hold the Test/Silence switch down and press the Pump 1 Mode button. A factory reset will clear all pump history records in the panel's memory.

Pump and System Counters

The Pivot tracks pump starts, elapsed-run times, and other system data. A programmed USB stick is required to extract this information from the panel. Format a USB thumb-drive as FAT32, create a new .txt file named "PivotConfig.txt", and write the phrase "ReadConfiguration" into the file. Insert the thumb-drive into the USB slot located near the bottom right side of the user interface bracket. The "System Ready" LED will blink quickly. Hold down the Silence toggle switch on the outside of the panel for 3 seconds, after which the "System Ready" LED will change to a slower blink pattern. The thumb-drive can now be removed from the USB port. The panel will have written a file to the drive called "FirmwareUpdateResults.txt" which contains the system data. All counter values are reported first behind the phrase 'NonvolatileVariables'. If the file, "FirmwareUpdateResults.txt" already exists on the thumb drive, the Pivot panel will simply write the new report below the previously written report. Note that all times are given in increments of 0.1 seconds: 10 = 1 second, 100 = 10 seconds, and 1000 = 100 seconds.

Operation

Powerup

Once the panel and floats are appropriately installed and power is routed, ensure that the enclosure is free of debris (wire clippings, tools, etc.) before engaging power from the breaker box or disconnect. Immediately after powerup, the Pivot alarm will briefly test, and the system will become operational. The pump mode(s) will default to the AUTO position and the system will check the float status. If sufficient water is present, the Pivot may begin a pump cycle.

Float Functionality

Operation by Float Sequence

- a) Simplex System with 3 Floats – **SSH (STOP, START, HIGH ALARM)** – Typical
 - 1) When water is below the STOP float, the pump is inactive.
 - 2) When water raises both STOP and START floats, the pump activates.
 - 3) If water continues to rise and activates the HIGH ALARM float, a high water alarm condition will occur. A high water alarm will continue until manually reset by an individual, even if the high water condition is alleviated.
 - 4) When water lowers below the STOP float, the pump stops.
- b) Duplex System with 3 Floats – **SLH (STOP, LEAD, LAG / HIGH ALARM)** – Typical
 - 1) When water is below the STOP float, both pumps are inactive.
 - 2) When water raises both STOP and LEAD floats, the lead pump starts running.
 - 3) If water continues to rise and activates the LAG / HIGH WATER float, the lag pump will be called to run in addition to the lead pump, and a high water alarm condition will occur. A high water alarm will continue until manually reset by an individual, even if the high water condition is alleviated.
 - 4) When water lowers below the STOP float, both pumps stop running.

- c) Duplex System with 4 Floats – **SLLH (STOP, LEAD, LAG, HIGH ALARM)** – Less Common
- 1) When water is below the STOP float, both pumps are inactive.
 - 2) When water raises both STOP and LEAD floats, the lead pump starts running.
 - 3) If water raises the LAG float, the lag pump starts running.
 - 4) If water continues to rise and activates the HIGH ALARM float, a high water alarm condition will occur. A high water alarm will continue until manually reset by an individual, even if the high water condition is alleviated.
 - 5) When water lowers below the STOP float, both pumps stop running.
- d) Duplex System with 4 Floats – **SLHL (STOP, LEAD, HIGH ALARM, LAG)** – Rare*
- 1) When water is below the STOP float, both pumps are inactive.
 - 2) When water raises both STOP and LEAD floats, the lead pump starts running.
 - 3) If water continues to rise and activates the HIGH ALARM float, a high water alarm condition will occur. A high water alarm will continue until manually reset by an individual, even if the high water condition is alleviated.
 - 4) If water raises the LAG float, the lag pump starts running.
 - 5) When water lowers below the STOP float, both pumps stop running.

***NOTE:** The Pivot is designed to operate using only 3 floats for the majority of applications (simplex and duplex). The use of only 3 floats is recommended. However, if local codes require the use of 4 floats in a residential or small commercial duplex application, it will be necessary to modify the Pivot panel's default settings regarding float order. Residential or small commercial duplex applications should utilize a Stop, Lead, High Alarm, Lag (SLHL) float order rather than the default Stop, Lead, Lag, High Alarm (SLLH) configuration. Refer to the section entitled 'Adjusting Defaults' for instructions on how to customize these settings.

Alarm Condition Faults

There are several system fault conditions which will activate the lighted alarm globe and horn. A list of the most common or serious fault sources with explanations are listed below.

- **High Control Voltage** – The Pivot control circuit is only designed to operate using 120V, single phase, 60 Hz power. If 230V power is mistakenly applied to this circuit, the panel will detect the issue and immediately enter a safe mode to prevent damage to components. Under this condition, most of the LEDs will begin blinking, but neither the globe nor the horn will activate. No panel functions are available when High Control Voltage is detected, and the only course is to cut the power supply and correct the issue. When appropriate 120V power is restored, the system will begin functioning properly.
- **Disabled Alarm Circuit** – The Pivot maintains circuits separately for control functions versus alarm functions. If the panel does not detect power on the alarm circuit, the panel will institute an emergency alarm in which the globe will double-blink, the horn will engage, and all the float LEDs will light solid Red. The system cannot be silenced if a Disabled Alarm Circuit is detected. The source of the issue must be identified and corrected, usually by either connecting power to the alarm circuit lugs, installing a jumper wire, or replacing a blown alarm fuse.
- **High Water Alarm** – When a high water condition occurs, the High Water alarm will activate. High water is indicated by the horn, a solidly lit globe, and a Red High Water LED indicator inside. The alarm globe will remain engaged (latched) to notify the user of an issue and will persist even if the water level has subsequently fallen below the lowest float level position. The alarm horn will sound for at least 1 minute unless manually silenced, but it will automatically silence once the high water condition is rectified. The high water alarm can only be cleared (reset) by pressing the external panel Silence/Test toggle switch to its Silence position and holding it for 3 seconds, then releasing it.
- **Float Fault** – Float faults can result from installation error, bad connections, or float malfunction. If the Pivot detects unusual feedback or out-of-order activation from any float, the panel will sound the horn, slow-blink the globe, and cause the status LED of the float in question to blink. A blinking Amber or Red float LED (including the High Water LED) should be checked for proper installation and operation. The alarm can only be cleared (reset) by pressing the external panel Silence/Test toggle switch to its Silence position and holding it for 3 seconds, then releasing it.
- **Continuous Run Alarm** – Pivot monitors the operation of the pump(s). If a pump operates continuously for more than 20 minutes (default), the panel assumes there is a problem and will sound an alarm. A Continuous Run Alarm is indicated by the horn, a solidly lit globe, and a blinking Amber Pump Run LED. The alarm can only be cleared (reset) by pressing the external panel Silence/Test toggle switch to its Silence position and holding it for 3 seconds, then releasing it.
- **Service Off Timeout** – If a pump is placed into Service Off mode (denoted by a solid Red HOA Off LED), the panel will start tracking the time. If the pump is still in Service Off mode after 4 hours (default) elapse, the panel will sound an alarm to remind the user that the pumps are disabled. The alarm is indicated by the horn, a double-blinking globe, and a Red blinking HOA Off LED. Changing the status of the pump with the Pump Mode button will clear the alarm. To place the pump directly into Permanent Off mode, press and hold the Pump Mode button for approximately 5 seconds.
- **Failed Contactor** – The panel monitors the contactor relay position. If a contactor fails to switch and remains in the wrong position it will trigger a failed contactor alarm condition marked by the horn, a fast-blinking globe, and a solid Red Pump Run LED. Correcting this fault requires panel service by a qualified electrician or installer.

The table below describes all the different fault conditions and provides the corresponding behaviors of the globe light and internal LEDs. To troubleshoot an alarm, match the observed conditions to those listed in the table.

Alarm Condition	Latching	Globe	User Interface LEDs				
			System Ready	High Water	Pump Run (1 or 2)	Pump Off (1 or 2)	Stop, Start/Lead, or Lag
Overload (3PH only)	No	Fast Blink	Off	Off	Solid Red	Off	Off
Failed Contactor	Yes	Fast Blink	Off	Off	Solid Red	Off	Off
Service Off Timeout	No	Double Blink	Off	Off	Off	Blinking Red	Off
Disabled Alarm Circuit	No	Double Blink	Off	Solid Red	Off	Off	Solid Red
Continuous Run	Yes	Solid	Off	Off	Blinking Amber	Off	Off
High Water Float Logic Error	Yes	Slow Blink	Off	Blinking Red	Off	Off	Off
Float Logic Error	Yes	Slow Blink	Off	Off	Off	Off	Blinking Red
Float Questionable	Yes	Slow Blink	Off	Off	Off	Off	Blinking Amber
High Water	Yes	Solid	Off	Solid Red	Off	Off	Off
High Control Voltage	Yes	Off	Blinking Green	Blinking Red	Blinking Red	Blinking Red	Blinking Red

ADJUSTING DEFAULTS

This Pivot Series Control Panel features a microprocessor-based logic that allows for the customization of certain features. The panel comes from the factory with settings appropriate for most applications and, except for rarer instances, should not need to be adjusted. Defaults can be modified in two ways: 1) Via physical pin jumpers on the Main Board or 2) with the use of a programmed USB thumb-drive (memory stick) formatted as FAT32. In order to provide for the most versatility, the Pivot is designed to recognize, accept, and keep the programming that was last modified, regardless of whether that programming came from the USB jump drive or from the pin jumpers. For more detailed procedures on changing the default values, visit the Pivot product site at www.zoellerpumps.com.

Modifying Defaults Via Pin Jumpers on the Main Board

There are 5 sets of jumper pins on the Pivot Main Board which are numbered 1 through 5. The Pivot comes from the factory with jumpers on each of the five pin sets. The user interface bracket and Main Board assembly must be removed from the enclosure in order to access the jumpers.

The pin jumpers on the Main Board are designed to configure the following settings:

Pin Jumper 1: Float Logic Type

Jumper Installed: *Smart* – Pivot monitors for signs of float failure and takes measures to keep the system operational in the event that issues are detected.

Jumper Removed: *Relay* – Pivot simply reacts to the float signals it detects similar to a relay logic-based panel.

Pin Jumper 2: Continuous Run Timeout

Jumper Installed: *Enabled* – If Pivot sees continuous pump operation for 20 minutes (Auto or Hand Mode), the panel will alarm, though pump operation will not be interrupted. In Duplex panels, the pumps will alternate at the 20 minute mark.

Jumper Removed: *Disabled* – Pivot will not alarm or alternate pumps regardless of continuous pump run time.

Pin Jumper 3: HOA Hand & Service Off Timeouts

Jumper Installed: *Enabled* – HOA Hand Timeout is set to 5 minutes and the HOA Service Off Timeout is set to 4 hours. Pivot will only allow the pump(s) placed in HOA Hand Mode to operate 5 minutes before switching the HOA Mode to Service Off. If the HOA Mode remains in Service Off for more than 4 hours, an alarm will sound.

Jumper Removed: *Disabled* – Pivot will not intervene when the HOA Mode is set to Hand. Nor will it intervene when the HOA Mode is set to Service Off.

Pin Jumper 4: Globe Mode

Jumper Installed: *Alarm Based* – The Pivot Globe will activate with different blink patterns depending on the alarm condition.

Jumper Removed: *Solid* – The Pivot Globe will only light solid red for any alarm conditions.

Pin Jumper 5: Duplex Float Configuration (no function for simplex panels)

Jumper Installed: *SLLH** – Stop, Lead, Lag, High Alarm

Jumper Removed: *SLHL* – Stop, Lead, High Alarm, Lag

***NOTE:** Despite the default settings for Float Count and Float Configuration, duplex Pivot panels are intended for use with only 3 floats in most applications. These defaults have been selected to provide the installer with the most diverse set of installation options possible without the need to manipulate the defaults. A jumper wire has been preinstalled from the factory in duplex models and links the Lag float terminal with the High Water float terminal. This jumper wire must be removed if 4 floats are used.

To access or modify the pin jumpers, the user interface bracket and Main Board assembly must first be removed from the enclosure.

WARNING: Disconnect all source power before proceeding with the removal of the Pivot Main Board.

To remove the Pivot Main Board, first ensure that no live power exists in control panel. Remove the two wiring harnesses which connect to the board below the user interface bracket. Next remove the two backplate screws on the left side of the panel (see image below, left). One screw is in the top-left corner and the other is in the bottom-left corner. Carefully slide out the user interface bracket and Main Board assembly. The pin jumpers are located on the board as shown in the image below, right. When removing pin jumpers, place the connector back onto only one pin so that it is available for future modifications if necessary. After all modifications are complete, reinstall the interface bracket and Main Board assembly by reversing the steps above. When power is restored to the panel, the Pivot will recognize the modifications.

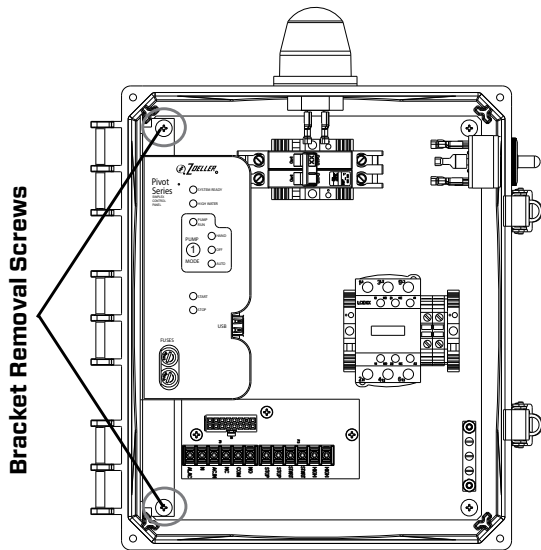

Removal of Interface Bracket / Main Board Assembly

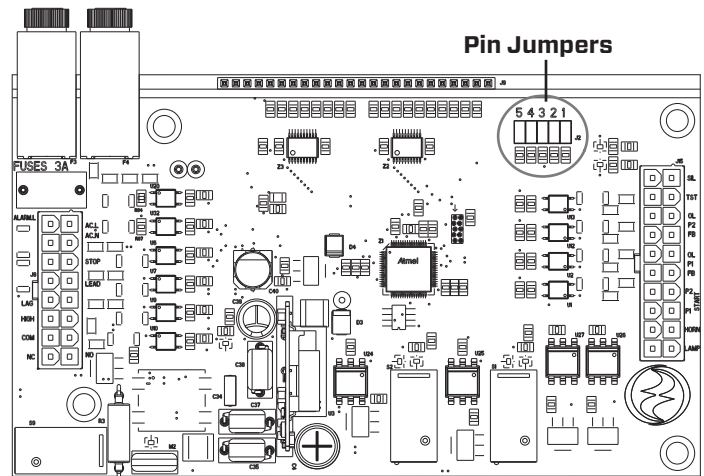

Location of Pin Jumpers on the Main Board

Modifying Defaults Via USB Memory Stick

The second method of modifying the default behavior of the Pivot panel is through a programmed USB thumb-drive (memory stick). The drive must be formatted as FAT32. The USB method provides greater control over the behaviors of the Pivot. The following list comprises the settings most likely to be adjusted:

System Mode – Sets if two pumps are allowed to run simultaneously (Duplex) or if only one pump is allowed to operate at a time (Alternator). This affects both HOA Hand Mode as well as Lag/High Alarm conditions.

Simplex Default: Simplex Options: No Options

Duplex Default: Duplex Options: Alternator

Float Count – Sets the number of floats for which the Pivot expects to receive input.

Simplex Default: 3 Options: 4

Duplex Default: 4* Options: 3

Float Configuration – Sets the expected order (lowest to highest) of floats in the tank

Simplex Default: SSH Options: No Options

Simplex Default: SLLH* Options: SLHL

***NOTE:** Despite the default settings for Float Count and Float Configuration, duplex Pivot panels are intended for use with only 3 floats in most applications. These defaults have been selected to provide the installer with the most diverse set of installation options possible without the need to manipulate the defaults. A jumper wire has been preinstalled from the factory in duplex models and links the Lag float terminal with the High Water float terminal. This jumper wire must be removed if 4 floats are used.

Float Logic Type – Sets whether Pivot attempts to intelligently discern float failure.

Default: *Smart* Options: *Relay*

Globe Mode – Sets the globe’s response to alarm conditions. ‘Alarm’ provides different patterns for different types of alarms.

Default: *Alarm* Options: *Solid, Blinking*

Horn Mode – Sets the horn’s response to alarm conditions. ‘Active’ will only activate the horn while the alarm condition is present. ‘Latching’ will continue to sound the horn until the panel is manually silenced.

Default: *Active* Options: *Latching*

Continuous Run Timeout – Sets the length of time (in tenths of seconds) that the panel will allow a pump to run before intervening.

Default: *12000* (20 minutes) Options: Any numeric up to *59400* (99 mins), ‘0’ disables the function

HOA Hand Timeout – Sets the length of time (in tenths of seconds) that the panel will allow a pump to run in Hand Mode before intervening.

Default: *3000* (5 minutes) Options: Any numeric up to *5400* (9 mins), ‘0’ disables the function

HOA Service Off Timeout – Sets the length of time (in tenths of seconds) that the panel will allow a pump to remain in Service Off Mode before intervening.

Default: *144000* (4 hours) Options: Any numeric up to *324000* (9 hrs), ‘0’ disables the function

To view the configurable values currently held in a Pivot panel, first format a USB thumb-drive as FAT32. To see the list of existing settings, create a new .txt file named “PivotConfig.txt”, and write the phrase “ReadConfiguration” into the file. Insert the thumb-drive into the USB slot located near the bottom right side of the user interface bracket. The Pivot panel’s System Ready LED will fast blink green. Hold down the Silence toggle switch on the outside of the panel for 3 seconds, wait for the LED to blink slower, then remove the thumb-drive. The panel will automatically write to the drive and create a new file named “FirmwareUpdateResults.txt” which will contain the system data. A partial list of variable names and their default values for a simplex panel is provided below:

ControllerConfig.SystemMode = SIMPLEX

ControllerConfig.FloatCount = 3

ControllerConfig.FloatConfiguration = SLLH

ControllerConfig.HornMode = ACTIVE

ControllerConfig.GlobeMode = ALARM

ControllerConfig.FloatLogicType = SMART

ControllerConfig.ContinuousRunTimeout = 12000

ControllerConfig.HOAHandTimeout = 3000

ControllerConfig.HOAServiceOffTimeout = 144000

To modify specific configurable values using a USB thumb-drive, write the full variable names and new values of the configurations you wish to modify (one per line) into the “PivotConfig.txt” file. Below the last line of your new settings, write the phrase “ReadConfiguration”. Insert the thumb-drive into the USB slot located near the bottom right side of the user interface bracket. The Pivot panel’s System Ready LED will fast blink green. Hold down the Silence toggle switch on the outside of the panel for 3 seconds, wait for the LED to blink slower, then remove the thumb-drive. The settings will have been modified and a file will have been written to the thumb-drive named “FirmwareUpdateResults.txt” which will contain evidence of the new, updated system data.

NOTICE!

Products intended for return must be cleaned, sanitized, or decontaminated as necessary prior to shipment to ensure that employees will not be exposed to health hazards in handling said material. All applicable laws and regulations shall apply.



MAIL TO: P.O. BOX 16347 • Louisville, KY 40256-0347
SHIP TO: 3649 Cane Run Road • Louisville, KY 40211-1961
Tel: (502) 778-2731 • 1 (800) 928-PUMP

Trusted. Tested. Tough.®

Visit our website:
zoellerpumps.com