

DRAWING REVISIONS				
LTR	BY	DATE	ECO #	DESCRIPTION
A	AF	06/21/21	11319	RELEASE
B	AF	11/05/21	11391	AC JUMPER WIRE REMOVED
C	PY	11/11/22	11437	TORQUE SETTING & NOTE ADDED
D	PY	05/30/23	11605	DRAWING UPDATES

CUSTOMER TORQUE SETTING		
NUMBER	COMPONENT	TORQUE
1	CONTACTORS	1.7 N.m. 15 lb-in
2	BREAKOUT TERMINAL BOARD	0.82 N.m. 7.3 lb-in
3	TERMINAL BLOCK 6mm ² -CROSS SECTION	1.5-1.8 N.m. 13.3-15.9 lb-in
	TERMINAL BLOCK 16mm ² -CROSS SECTION	2.5-3 N.m. 22.1-26.5 lb-in

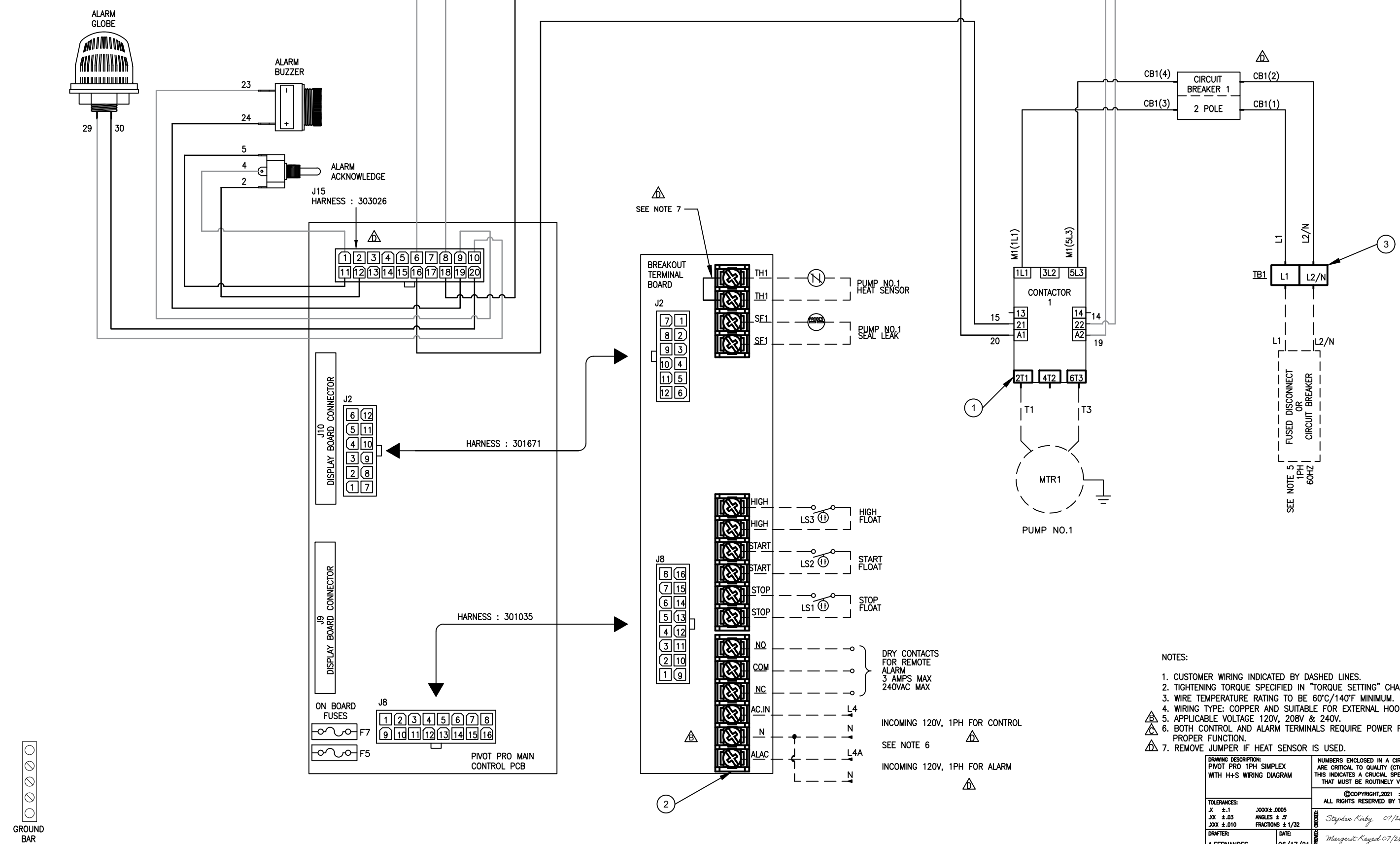

WARNING:
SEPARATE OVERCURRENT PROTECTION IS REQUIRED TO BE PROVIDED IN ACCORDANCE WITH PREVAILING LOCAL CODES (NFPA70: NATIONAL ELECTRICAL CODE OR CANADIAN ELECTRICAL CODE PART 1)

NOTICE:
THESE ARE INFORMATIONAL SCHEMATICS ONLY. THEY DO NOT REPLACE PROFESSIONAL GUIDANCE WITHIN ANY JURISDICTION OR FOR ANY APPLICATION AND SHOULD NOT BE RELIED UPON TO DO SO

- NOTES:**
- CUSTOMER WIRING INDICATED BY DASHED LINES.
 - TIGHTENING TORQUE SPECIFIED IN "TORQUE SETTING" CHART.
 - WIRE TEMPERATURE RATING TO BE 60°C/140°F MINIMUM.
 - WIRING TYPE: COPPER AND SUITABLE FOR EXTERNAL HOOKUP
 - APPLICABLE VOLTAGE 120V, 208V & 240V.
 - BOTH CONTROL AND ALARM TERMINALS REQUIRE POWER FOR PROPER FUNCTION.
 - REMOVE JUMPER IF HEAT SENSOR IS USED.

TULSAR END ITEM#	
EPA1352-0001	
EPA1312-0001	
EPA1322-0001	
EPA1332-0001	
EPA1342-0001	

ZOELLER
PUMP COMPANY

DRAWING DESCRIPTION: PIVOT PRO 1PH SIMPLEX WITH H+S WIRING DIAGRAM	NUMBERS ENCLOSED IN A CIRCLE (1, 2, 3) ARE CRITICAL TO QUALITY (CTQ) ITEMS. THIS INDICATES A CRUCIAL SPECIFICATION THAT MUST BE ROUTINELY VERIFIED.
TOLERANCES: X ±.1 XX ±.03 XXX ±.010	ANGLES ± 5° FRACTIONS ± 1/32
DRAFTER: A.FERNANDES	DATE: 06/17/21
APPROVED BY: Margaret Kaye 07/26/23	DATE: 07/26/23
ELECTRONIC SCALE: 1X DO NOT SCALE PRINT EXCEPT AS NOTED DIMENSIONS ARE IN INCHES.	PART NUMBER: 302722 PART REVISION: A DRAWING NUMBER: 302722 SHEET: 1 OF 3

GROUND BAR

1
2
3
4
5
6
7
8
9
10
11
12
13
14
15
16
17
18
19
20

21
22
23
24
25
26
27
28
29
30
31
32
33
34
35

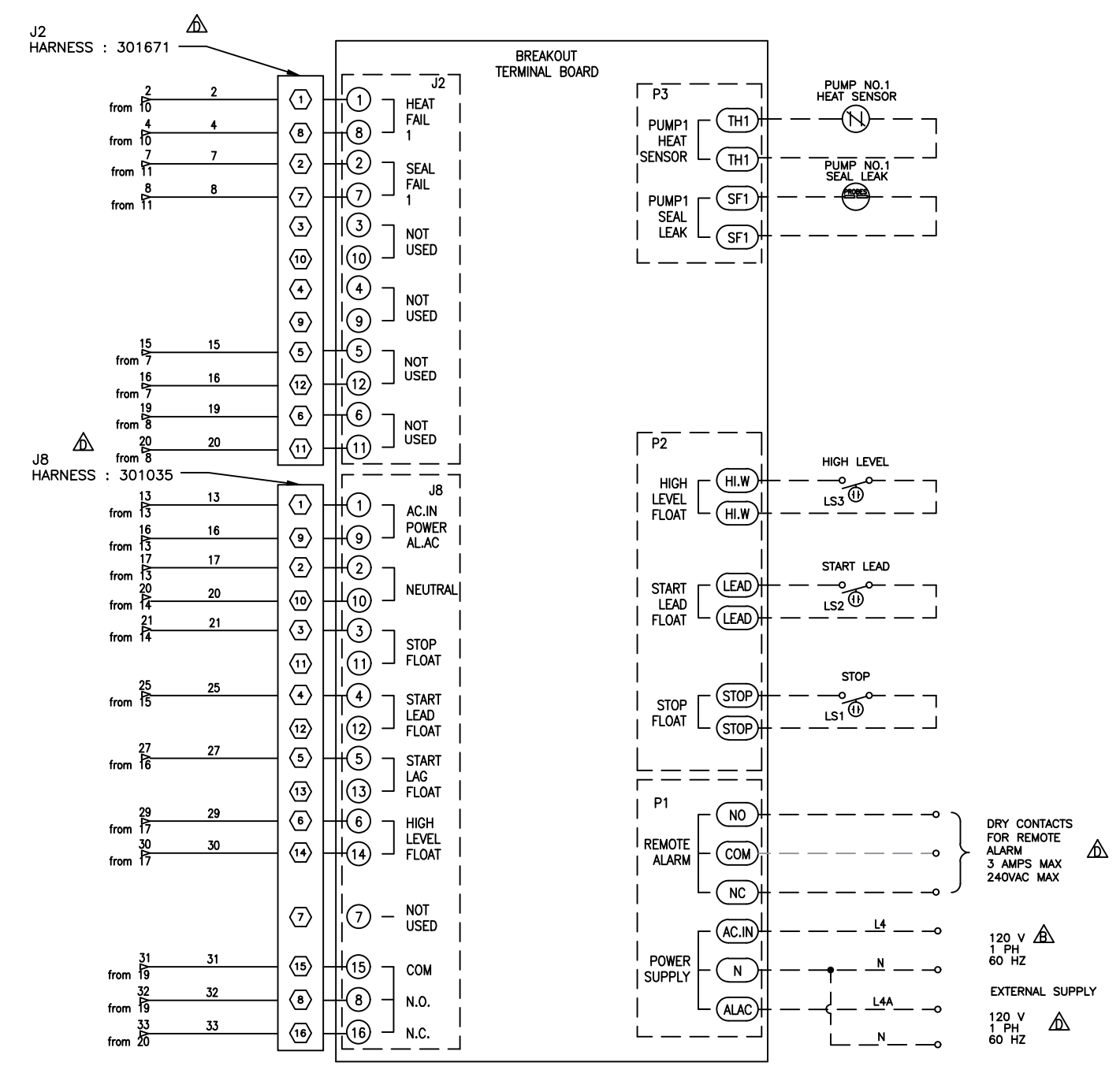
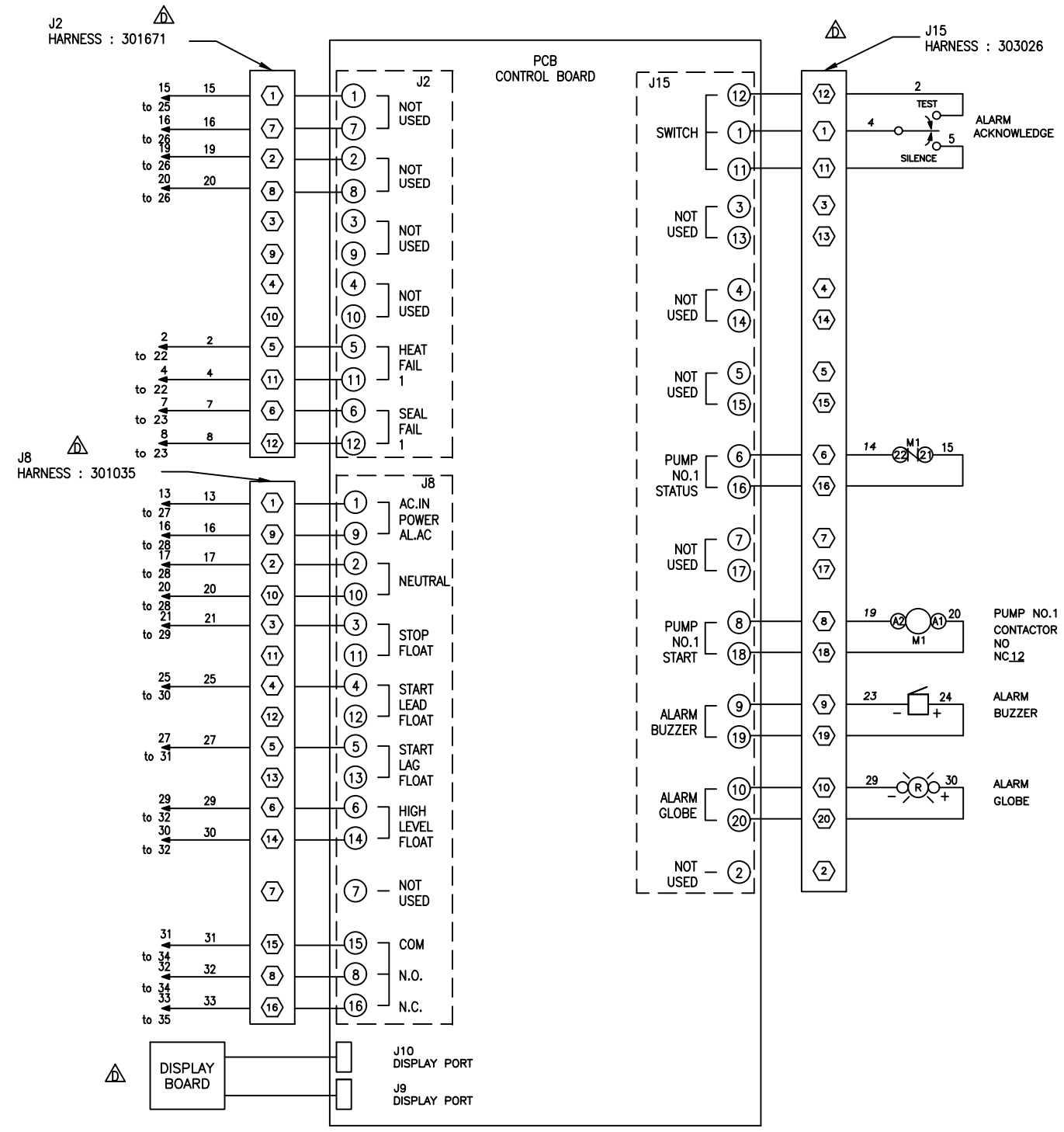

TERMINAL LEGEND
 DENOTE MOLEX PIN

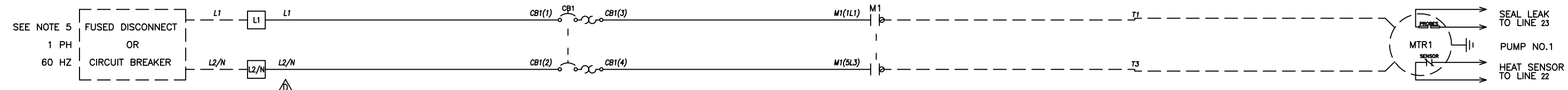

36
37
38
39
40
41
42
43
44
45
46
47
48
49
50
51
52
53
54
55

MOLEX DETAILS

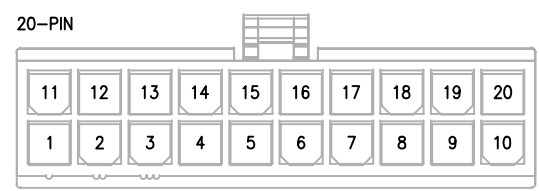
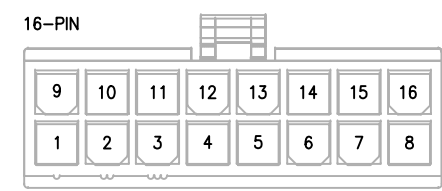
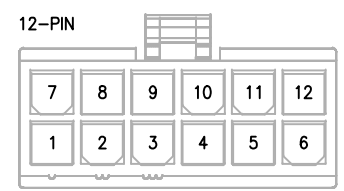

TERMINAL LEGEND
□ DENOTE LOCAL TERMINAL

ZOELLER PUMP COMPANY

THIS SHEET MUST BE ACCOMPANIED BY ALL RELATED SHEETS.
DRAWING NUMBER: 302722
SHEET: 3 OF 3